

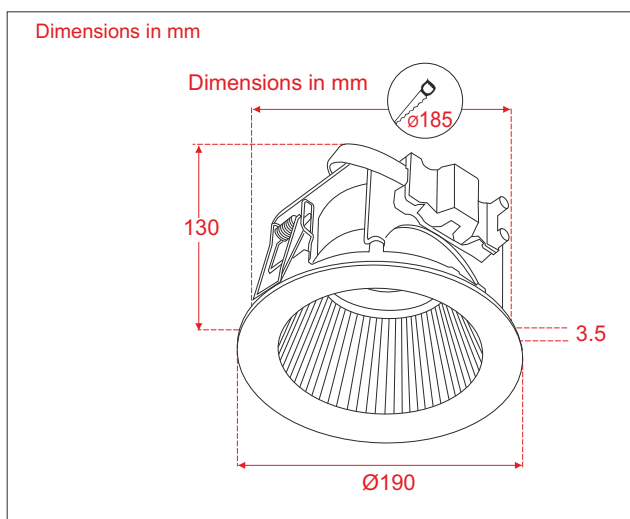

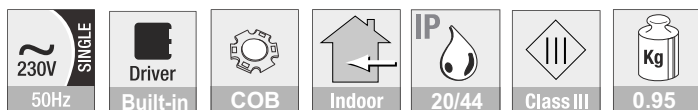



A0135190 Mainz-R 190 WW 28W 2289Lm 3000K

Aluminum white anodized cover ring

Lamp type: recessed down-light

CRI: 80
 UGR: <19
 Beam angle reflector: 50°
 Operating Power: 220-230VAC/50Hz
 Housing: solid Aluminum
 Reflector: Aluminum/anti-glare
 Cover Ring: PMMA White
 Weight: 0.95 Kg
 Dimensions fixture: ø190 x 130 mm
 Classification: IP20 Class III
 Cable length: 1000mm
 Included (internal) LED-driver
 IES-Files available



Height	Mainz-R 190WW 50°	Ø m	Emax
0.5m		0.47	3096 Lx
1.0m		0.94	774 Lx
1.5m		1.41	484 Lx
2.0m		1.88	194 Lx
2.5m		2.35	140 Lx
3.0m		2.82	86 Lx