

LANDA-2 WW





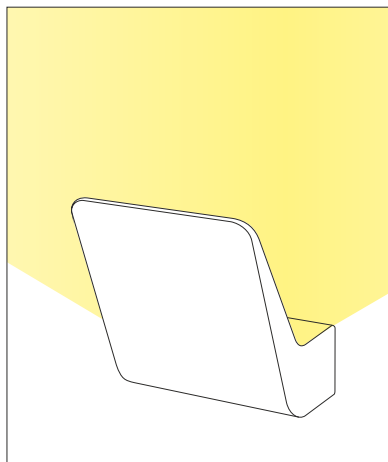
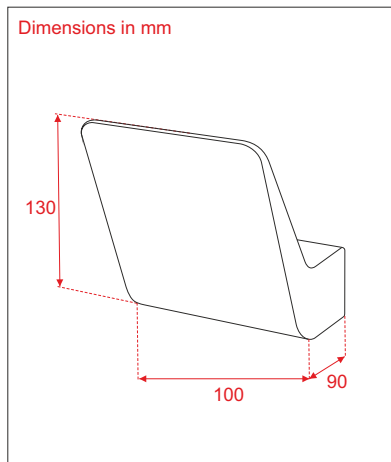
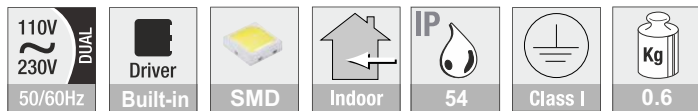

Ordernr: A0240086

Lamp type: Surface wall-light
 9x 0.3W Samsung 2323 warm-white 3000K SMD LED 120°
 Lightoutput: 184.23Lm
 Vf: 9.04VDC (max.Vf:11.6V)
 Light direction: indirect - up

Built-in 350mA (IP65 Gallop 04AP-P UNI) 3-4W LED-driver 9-14Vf
 Operating Power: 100-240VAC 50/60Hz
 Ta: -20°C - +45°C
 Power consumption: 3.164W

Housing: 10mm Aluminium RAL 9003 white powdercoated
 Weight: 0.6 Kg
 Dimensions fixture WxHxD: 130 x 100 x 90 mm
 Classification: IP-54 Class-1



Height	Landa-2 WW 92.95°	Øm	Avg.	Nadir.E
0.5m		1.05m	147 Lx	334 Lx
1.0m		2.10m	37 Lx	84 Lx
1.5m		3.15m	23 Lx	53 Lx
2.0m		4.19m	9.2 Lx	21 Lx
2.5m		5.19m	6.7 Lx	15 Lx
3.0m		6.29m	4.1 Lx	9.3 Lx

ISOCANDELA DIAGRAM

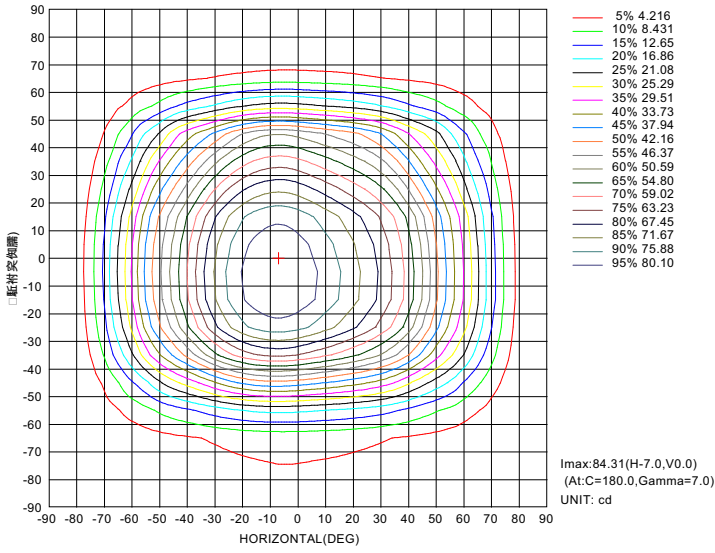

Flux out:129.0 lm

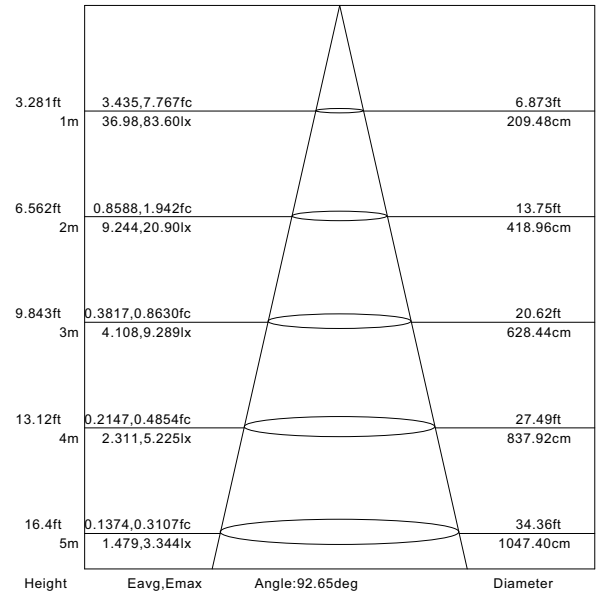

ISOLUX DIAGRAM

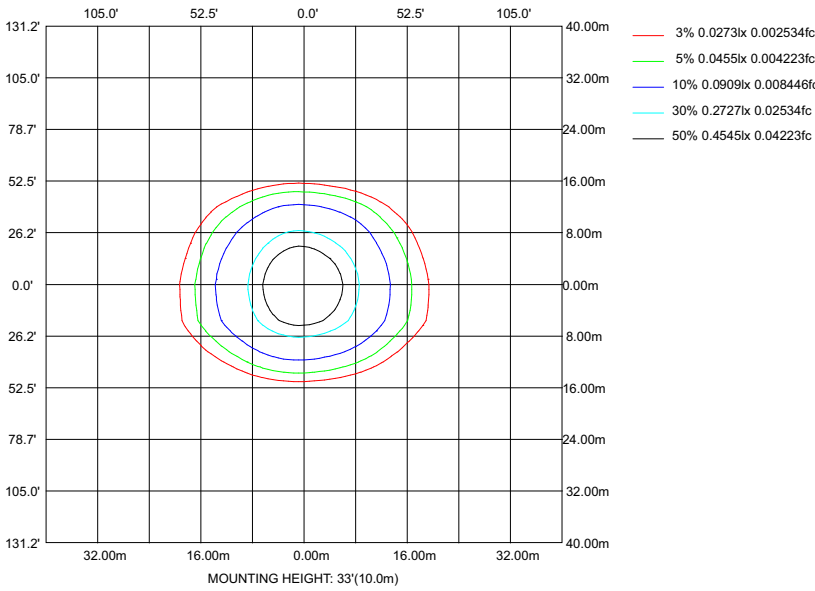

LUMINOUS INTENSITY DISTRIBUTION DIAGRAM

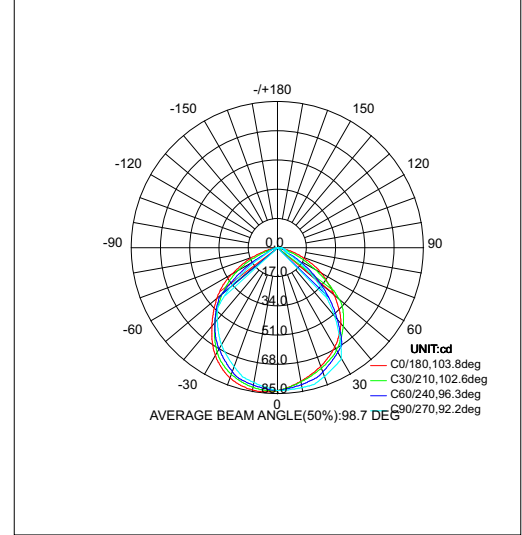

Planar Illuminance Curve

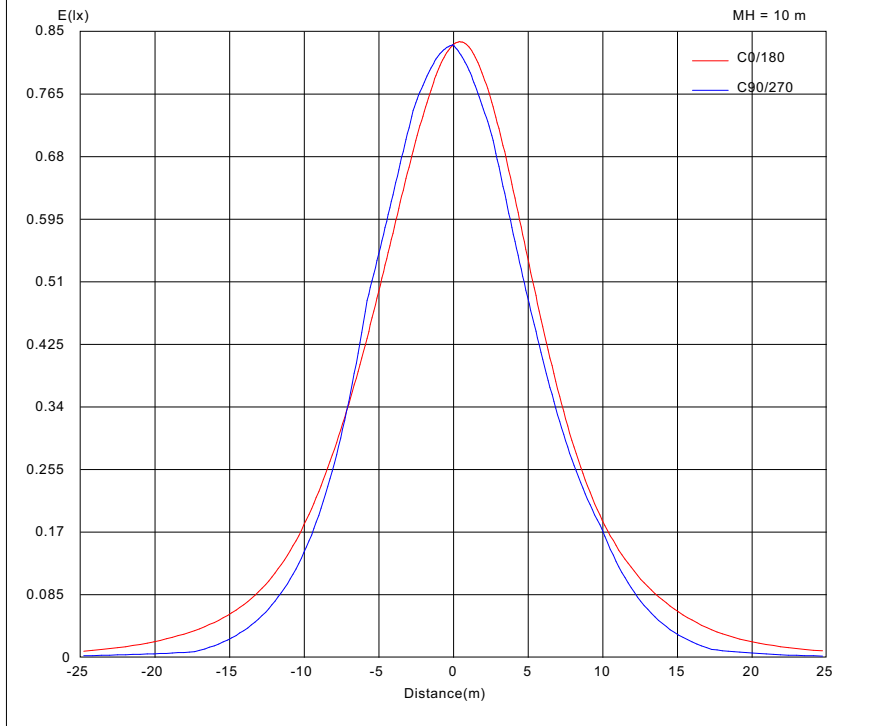

C0 PLANE ISOLUX DIAGRAM (UNIT:lx)

