

Index	2	Florence ceiling units	4
Safety information	2	Wiring diagram MT drivers	6
Content	2	Wiring diagram LDC-41 dimmer	7
Technical	3	Wiring diagram MTD drivers	8
Specifications	3	Accessories	9
Installation	4	List of symbols	10

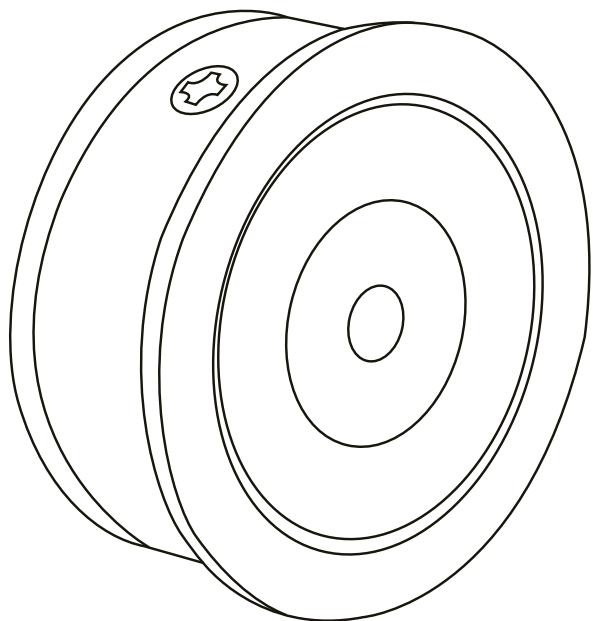

SAFETY INFORMATION

<p>Always switch off mains power of the driver before connecting or maintaining any fixtures!</p>			<p>Do not stare into the LED</p>	<p>Ambiance Max. 40°</p>	<p>Qualified technician</p>
	<p>Make sure all connectors are connected properly</p>	<p>Use a source of AC power that complies to local electrical codes</p>	<p>Block access below the work area when maintaining the unit</p>	<p>Don't modify or install genuine parts on this product</p>	<p>Don't install in a flammable or explosive area</p>

CONTENT

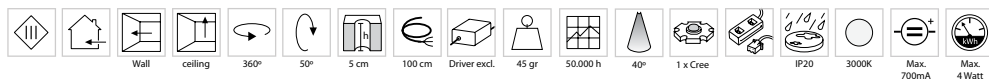
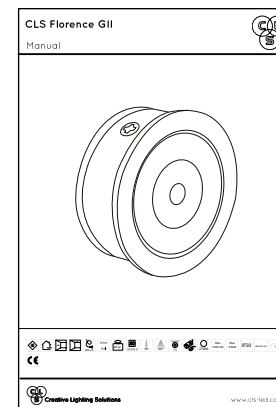
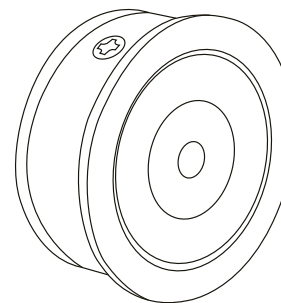

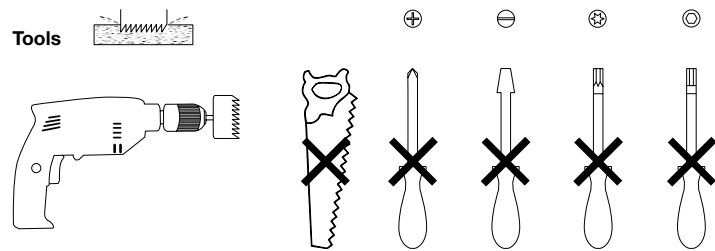
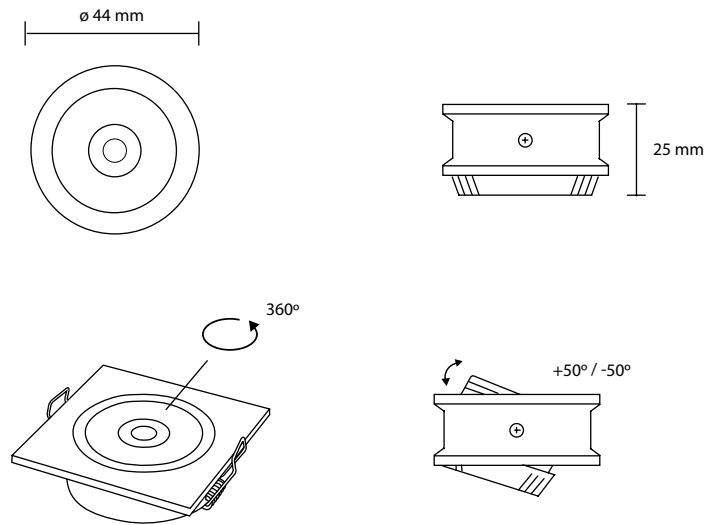

SPECIFICATIONS

LED: 1 x Cree
 Available colours: Warm white 3000K
 Lenses: 40°
 Power supply: Max. 700mA
 Power consumption: Max. 3 Watt
 Housing: Aluminum brushed
 Weight: 45 gr
 IP value: IP40
 Cable length: 100 centimeter
 Swivel angle: +50° / -50°, rotate 360° (placed in ceiling unit)
 Measurements: ø 44 x 25 mm (øxh)
 Ambient temperature: -10° C till +40° C

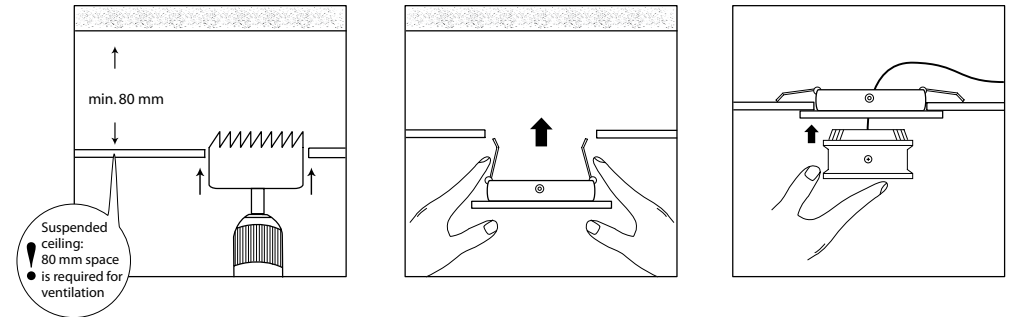

FLORENCE CEILING UNITS

Florence round ceiling unit 1 hole

Item nr: 87129060
 Measurements: ø 60 x 20 mm (øxh)
 Cut-out size: ø 51 mm
 Housing: Aluminum brushed

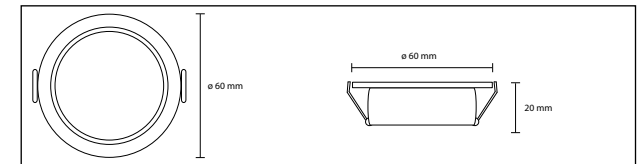

Florence square ceiling unit 1 hole

Item nr: 87129070
 Measurements: 20 x 60 x 60 mm (hxwxd)
 Cut-out size: ø 51 mm (øxh)
 Housing: Aluminum brushed

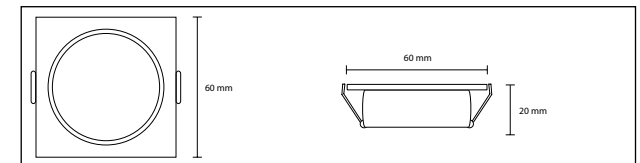

Florence rectangular ceiling unit 2 holes

Item nr: 87129080
 Measurements: 20 x 112 x 60 mm (hxwxd)
 Cut-out size: 101 x 51 mm (wxd)
 Housing: Aluminum brushed

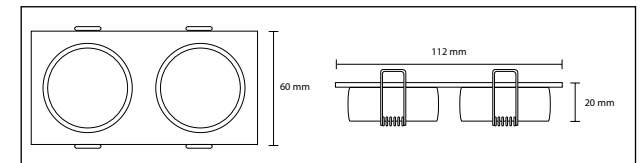

FLORENCE CEILING UNITS

WIRING DIAGRAM MT DRIVERS

Florence rectangular ceiling unit 3 holes
 Item nr: 87129090
 Measurements: 20 x 164 x 60 mm (h x w x d)
 Cut-out size: 155 x 51 mm (w x d)
 Housing: Aluminum brushed

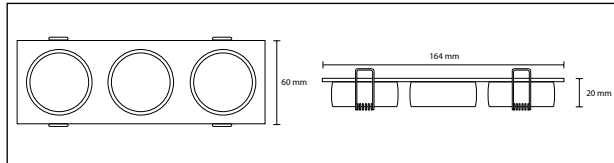

Florence rectangular ceiling unit 4 holes
 Item nr: 87129095
 Measurements: 20 x 217 x 60 mm (h x w x d)
 Cut-out size: 205 x 51 mm (w x d)
 Housing: Aluminum brushed

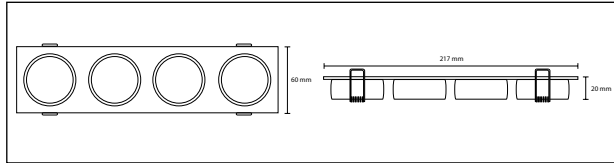

Florence rectangular ceiling unit 5 holes
 Item nr: 87129099
 Measurements: 20 x 267 x 60 mm (h x w x d)
 Cut-out size: 257 x 51 mm (w x d)
 Housing: Aluminum brushed

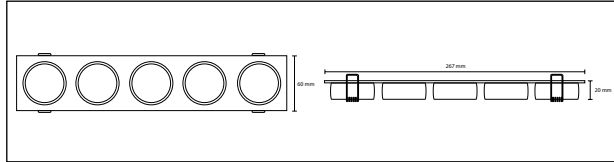

Florence square ceiling unit 4 holes
 Item nr: 87129150
 Measurements: 20 x 110 x 110 mm (h x w x d)
 Cut-out size: 100 x 102 mm (w x d)
 Housing: Aluminum brushed

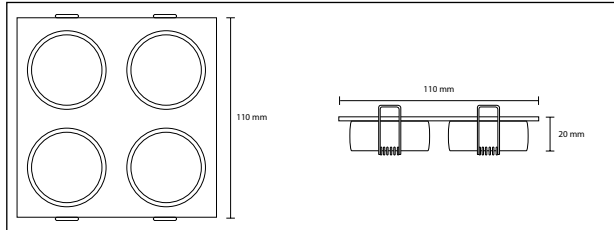

! Always switch off mains power of the driver before connecting any fixtures!

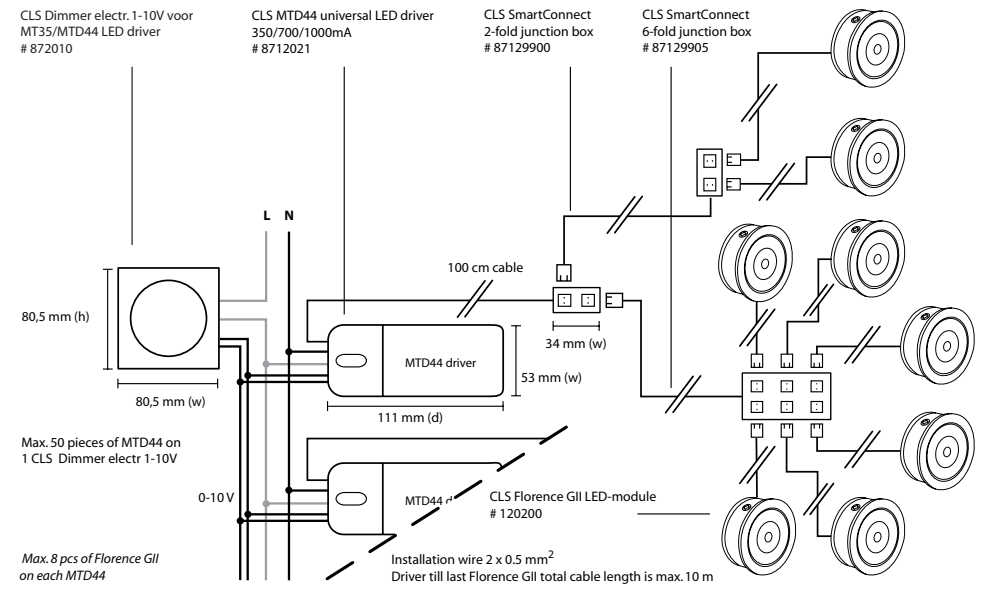
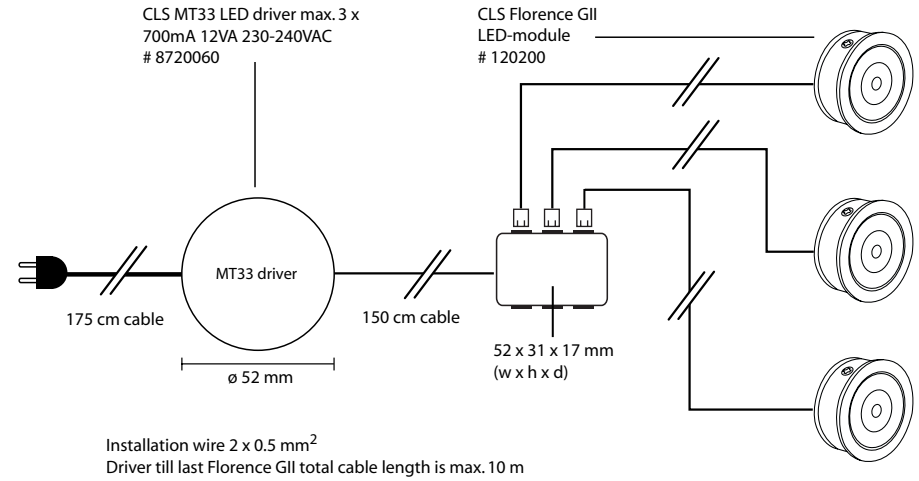

WIRING DIAGRAM LDC-41 DIMMER

! Always switch off mains power of the driver before connecting any fixtures!

Make sure the LDC-41 is set to 700mA!

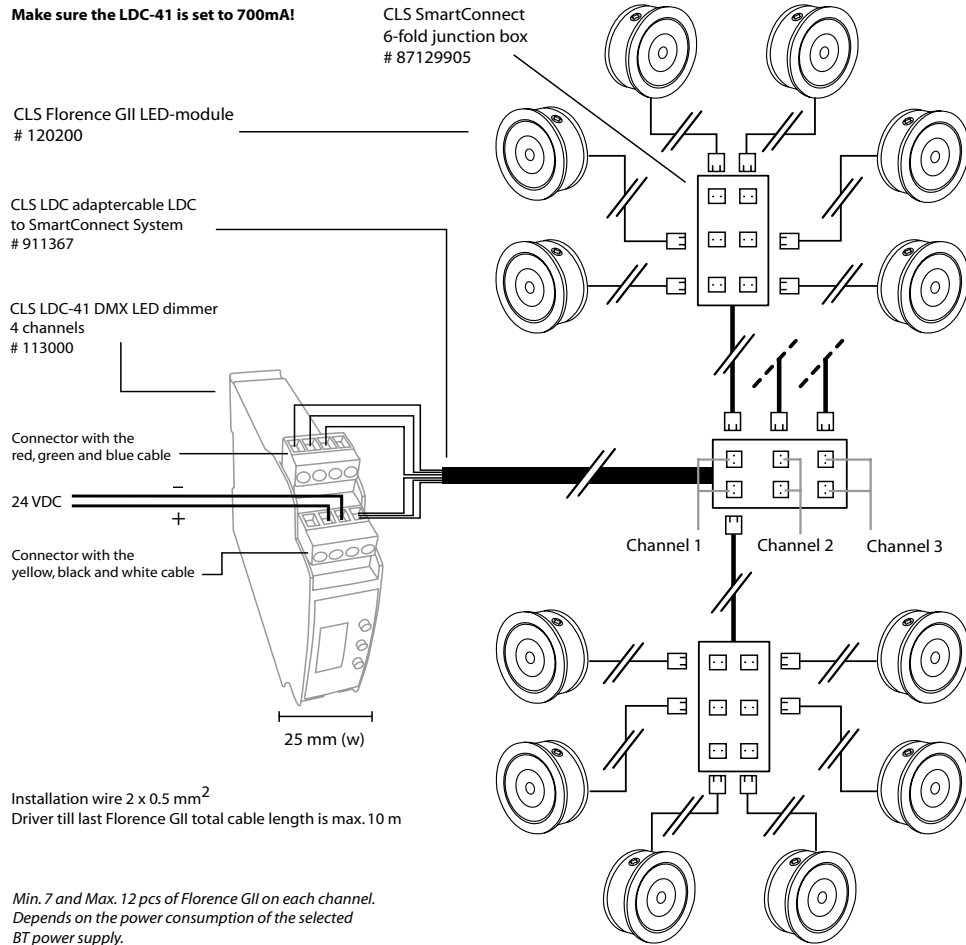

WIRING DIAGRAM MTD DRIVERS



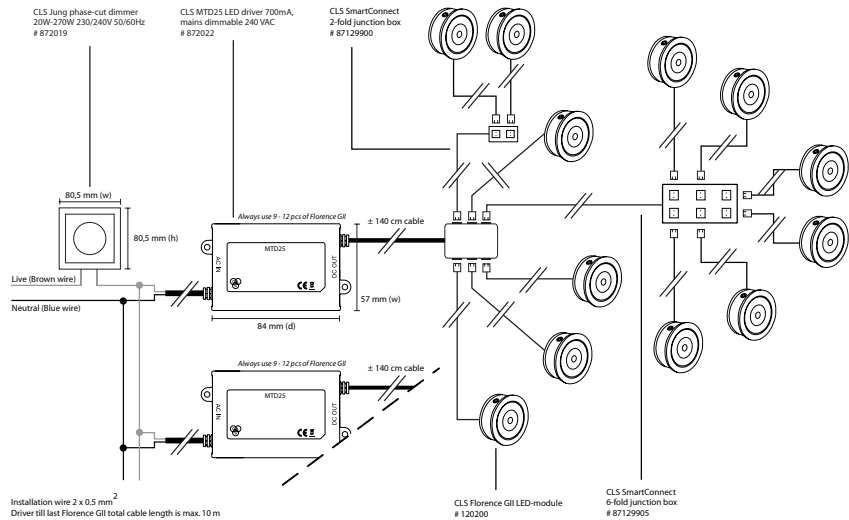
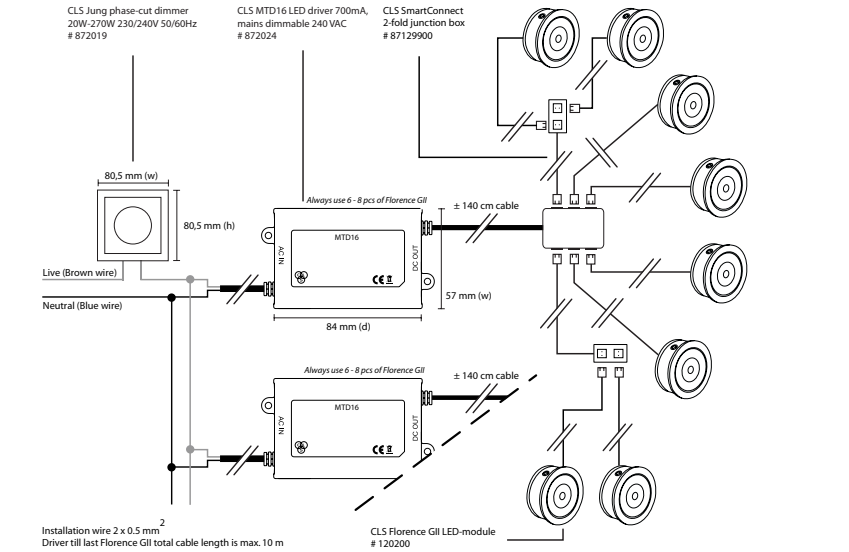











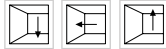



















! Always switch off mains power of the driver before connecting any fixtures!



ACCESSORIES

113000	CLS LDC-41 DMX LED dimmer 4 channels 0.35-1A per channel
87129060	CLS Florence round ceiling unit alu-brushed 1 hole
87129070	CLS Florence square ceiling unit alu-brushed 1 hole
87129080	CLS Florence rectangular ceiling unit alu-brushed 2 holes
87129090	CLS Florence rectangular ceiling unit alu-brushed 3 holes
87129095	CLS Florence rectangular ceiling unit alu-brushed 4 holes
87129099	CLS Florence rectangular ceiling unit alu-brushed 5 holes
87129150	CLS Florence square ceiling unit alu-brushed 4 holes
87129900	CLS SmartConnect 2-fold junction box & shortcircuit connect.
87129905	CLS SmartConnect 6-fold junctionbox & shortcircuit connect.
87129915	CLS SmartConnect short circuit plugs (10pcs)
87129959	CLS SmartConnect extensioncable betw. 2 junctionboxes 5mtr
872010	CLS Dimmer electr. 1-10V for MT35/MTD44 LED driver
872018	CLS MTD43 LED driver 4x700mA/8x350mA 12VA mains dimmable
872019	CLS Dimmer Jung phase cut max. 270VA 230-240VAC
872021	CLS MTD44 universal LED driver 350/700/1000mA
872022	CLS MTD25 LED driver 700mA 9-12 LEDsmains dim.
872024	CLS MTD16 LED driver 700mA 6-8 LEDs mains dim.
8720060	CLS MT33 LED driver for max 3pcs 700mA LEDs 220-240VAC
911367	CLS LDC adaptercable LDC to SmartConnect system

2015 CLS-LED BV. All rights reserved. Information subject to change without notice, CLS-LED BV and all affiliated companies disclaim liability for injury, damage direct or indirect loss, consequential or economic loss or any other loss occasioned by the use of, inability to use or reliance on the information contained in this manual. No part of this manual may be reproduced, in any form or by any means, without permission in writing from CLS-LED BV. Other legal information can be found in our General conditions, found on the back of your CLS-LED BV invoice, inside the CLS catalogue or on our website www.cls-led.com/voorwaarden.pdf

	Protection class One, two or three		IP value Ingress Protection classifies the degrees of protection provided against the intrusion of the product
	Application area Indoor or outdoor		Colour Available colours; Amber, blue, red or green
	Application area Floor, wall or ceiling		White colour temperature In different Kelvin values; Cold white, neutral white, warm white or extra warm white
	Swivel Fixture is horizontally rotatable, indicated in degrees		Colour changing RGB, RGB-W, RGB-A or ABW
	Swivel Fixture is vertically rotatable, indicated in degrees		Dynamic White Stepless control of white light
	Multiple connection Daisychain connectivity		Curve Minimal bending curve in centimeters
	Installation depth In centimeters		Cutting length Indicated by the cutting marks
	Installation size In centimeters		LED pitch Pitch between the LEDs in millimeters
	Cable length Maximum cable attached to the fixture in centimeters		Power supply In VDC, VAC or milliAmpere
	Driver Inclusive or exclusive		Power consumption In VA or Watt
	Weight In grams/kilograms		Dimmable 1-10 Volt, Phase, individual or DMX dimmable
	Pressure Maximum pressure on the fixture in kg/cm ²		Magne dimming Accurate dimming from 100 - 1% by using a magnet
	Lifespan Of the light source in hours		DMX input Fixture works on DMX512 protocol
	Lenses Available lenses, indicated in degrees		Combined product Compose your own fixture
	Warranty 3 years warranty on the product		
	LEDs Kind of LED used in the fixture		Conformité Européenne CE marking for free marketability of industrial goods within the EU
	Plug & play Easy connection using the SmartConnect system		Energy label